

# Contender

CN-24-B / CN-24-S  
 CN-30-B / CN-30-S  
 CN-36-B / CN-36-S  
 CN-48-B

The Contender has become a market leader proving its dependability time after time. A good all around work horse, the Contender offers a strong construction combined with a sleek and ergonomic appearance. System comes with a carry bag and is available in black or silver.



3-piece bungee pole

## features and benefits:

- Easily customizable heights
- American made
- Optional 4th pole for added height
- Supplied with quality carry bag
- Premium grip rail
- Standard height of 77.5"
- Quick and easy to assemble
- Lifetime warranty against all manufacturer defects

## dimensions:

Hardware	Graphic
<p><b>Base dimensions (with swivel foot extended):</b></p> <p><b>Contender Mini:</b>            16"l x 24.5"w x 3.25"h            406mm(l) x 622mm(w) x 83mm(h)</p> <p><b>Contender Standard:</b>            16"l x 30.5"w x 3.25"h            406mm(l) x 775mm(w) x 83mm(h)</p> <p><b>Contender Mega:</b>            16"l x 36.5"w x 3.25"h            406mm(l) x 927mm(w) x 83mm(h)</p> <p><b>Contender Monster:</b>            16"l x 48.5"w x 3.25"h            406mm(l) x 1232mm(w) x 83mm(h)</p> <p>All bases are 4"w without swivel foot extended</p>	<p>Refer to related graphic template for more information</p> <p>Visit: <a href="http://www.exhibitors-handbook.com/graphic-templates">www.exhibitors-handbook.com/graphic-templates</a></p>
<p>Shipping</p> <p><b>Shipping weight &amp; dimensions (ships in 1 box):</b></p> <p><b>Contender Mini:</b> 8 lbs / 3.6 kg            30"l x 6"w x 6"h            762mm(l) x 152mm(w) x 152mm(h)</p> <p><b>Contender Standard:</b> 9 lbs / 4 kg            34"l x 6"w x 6"h            864mm(l) x 152mm(w) x 152mm(h)</p> <p><b>Contender Mega:</b> 11 lbs / 5 kg            40"l x 6"w x 6"h            1016mm(l) x 152mm(w) x 152mm(h)</p> <p><b>Contender Monster:</b> 13 lbs / 5.9 kg            52"l x 6"w x 5"h            1321mm(l) x 152mm(w) x 127mm(h)</p>	<p><b>additional information:</b></p> <p><b>Included in kit:</b>            Top rail, base, pole set and carry bag</p> <p>Graphic material: Flexible inkjet, premium 100% opaque fabric or vinyl, 12 mil max thickness</p> <p>Lighting is available</p>

We are continually improving and modifying our product range and reserve the right to vary the specifications without prior notice. All dimensions and weights quoted are approximate and we accept no responsibility for variance. E&OE. See Graphic Templates for graphic bleed specifications.

## Assembly Instructions

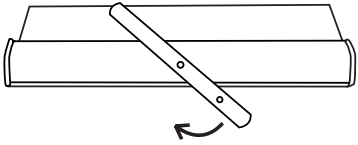

Swivel foot so pole hole is in the back of the unit.

1

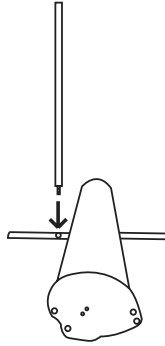

Twist pole into swivel foot.

2

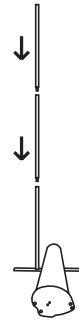

Twist the remain pole sections into place.

3

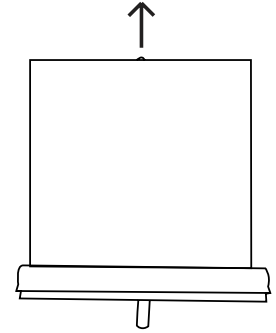

Pull graphic from base.

4

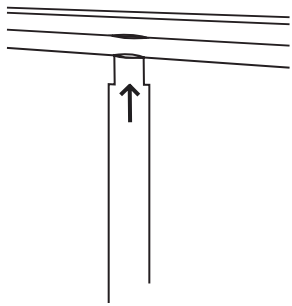

Attach top of graphic to top of pole.

5



Unit is complete.

6

## 4th Pole Attachment



For extra height, add a 4th section to the pole.

1



Unit is complete.

2

## Grippa Top Rail Attachment

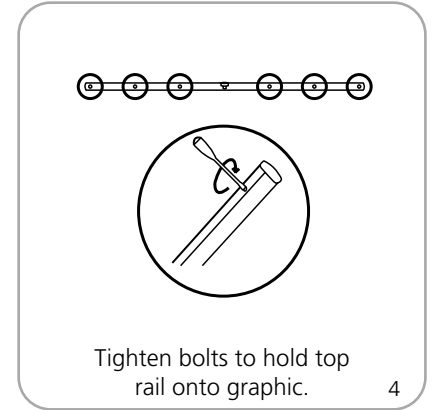
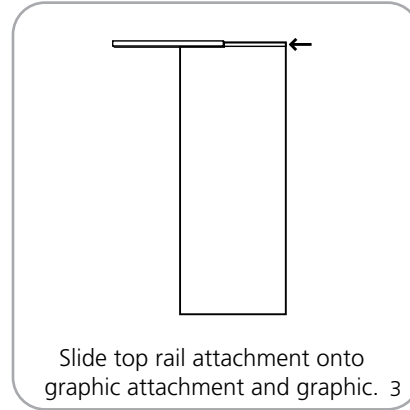
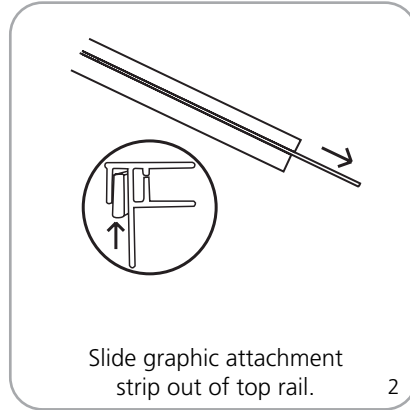
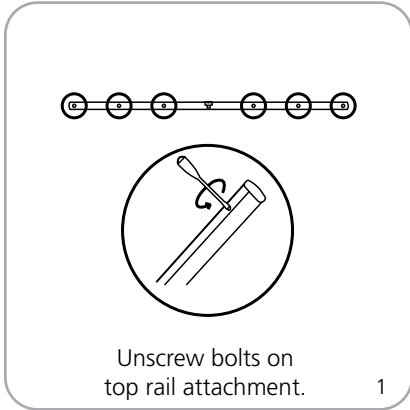

## Attaching Graphic to Leader Strip

