

# Coyote L-Shape & Star

The Coyote popup display system combines strength, reliability, and style in a lightweight and easy to use system. It is fully magnetic, making it simple to assemble and disassemble, and is available in a wide range of sizes and configurations.

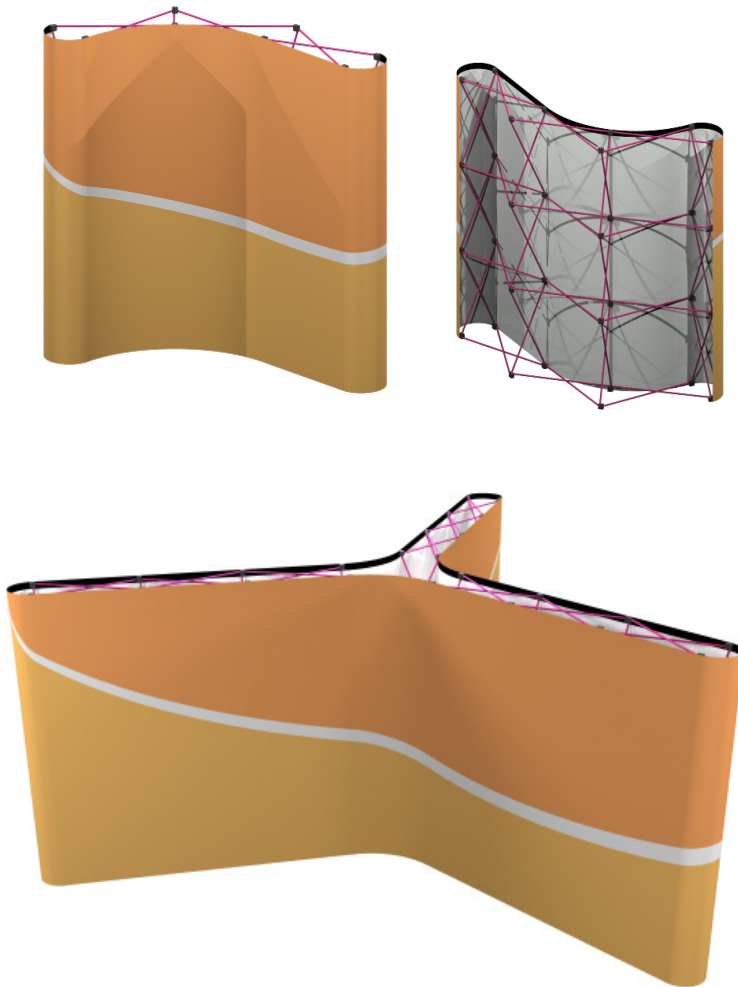

## Features and Benefits

- Quick to set up
- Easy to store and ship
- LED lighting available
- Collapses to a fraction of its size
- Molded case for easy transportation
- Able to accommodate a variety of accessories
- Available in L or Star shape in a variety of sizes

## Display Dimensions

See pages 1 & 2

Height:  
3 Quad: 87.5625 / 2224.08mm

## Additional Information

### Graphics:

- If printing own graphics, magnet must go directly to edge of panel
- Must use included hanger for back of panels

Weight: Varies per kit

Lighting options available

Available Options (all can be added to existing Coyote):

- Case to Counter conversion (roll or stretch wrap)
- Bubble Panel
- Internal Shelf Kit
- Monitor Stand



### 3x3 L Shape Kit:

Ships in 1 OCP, 26" x 16" x 44", 76 lbs  
660.4mm x 406.4mm x 1117.6mm, 34.5 kg

### 4x3 L Shape Kit:

Ships in 1 OCP, 26" x 16" x 44", 89 lbs  
660.4mm x 406.4mm x 1117.6mm, 40.4 kg

### 5x3 L Shape Kit:

Ships in 1 OCP, 26" x 16" x 44", 94 lbs  
660.4mm x 406.4mm x 1117.6mm, 42.6 kg

### 2x3 Star Kit:

Ships in 3 OCP, each 26" x 16" x 44", Each 97 lbs  
660.4mm x 406.4mm x 1117.6mm, 44 kg

### 3x3 Star Kit:

Ships in 4 OCP, each 26" x 16" x 39", Each approx 76 lbs  
660.4mm x 406.4mm x 1117.6mm, 34.5 kg

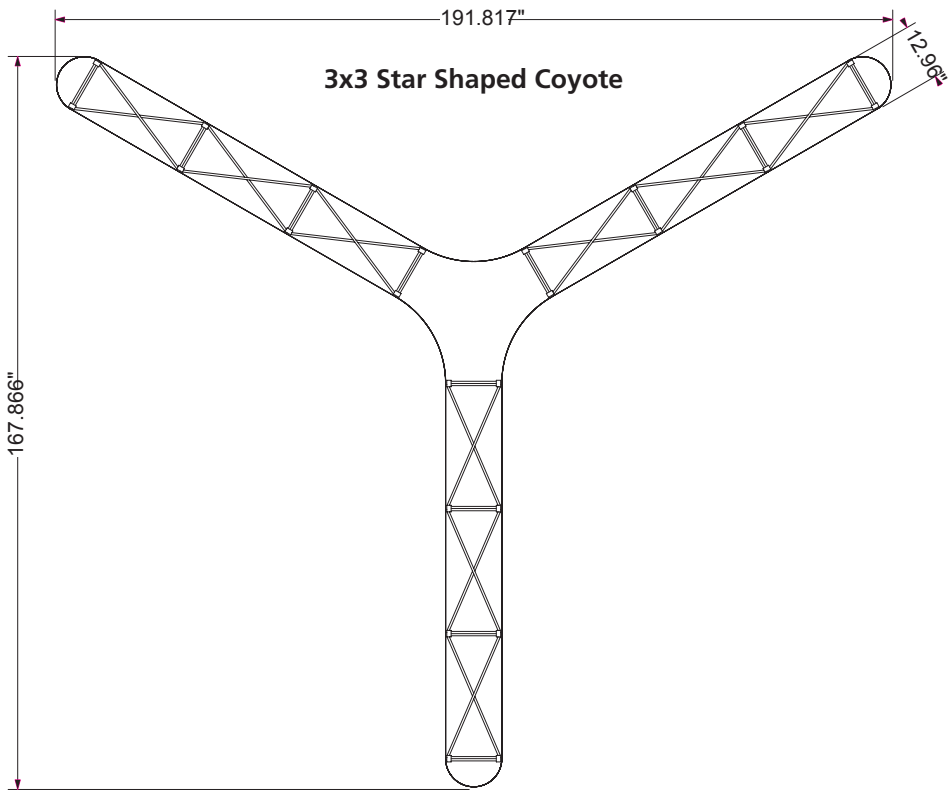
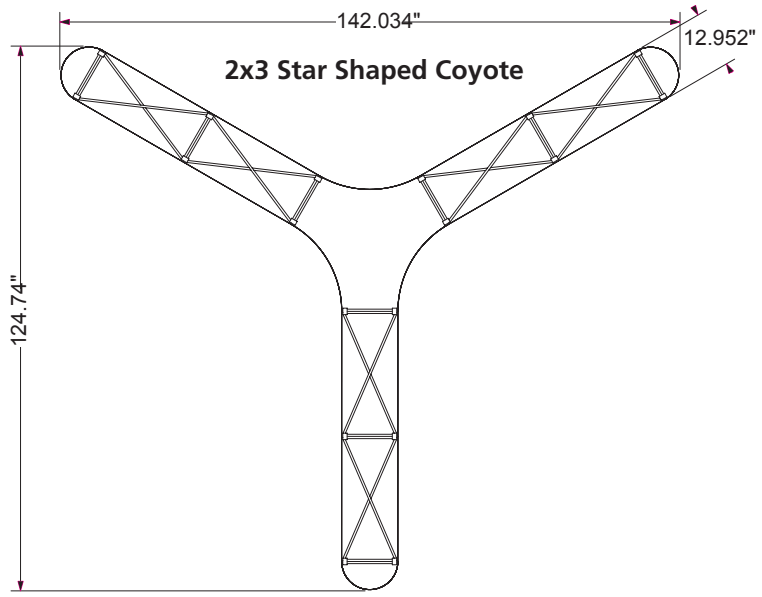

**3x3 L Shaped Coyote**

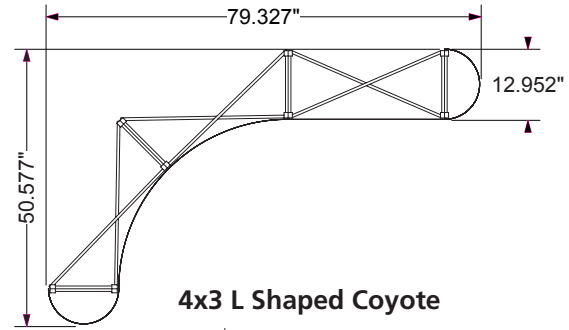

**4x3 L Shaped Coyote**

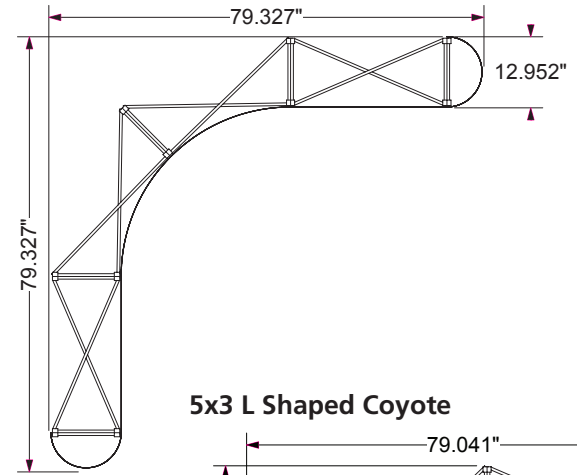

**5x3 L Shaped Coyote**

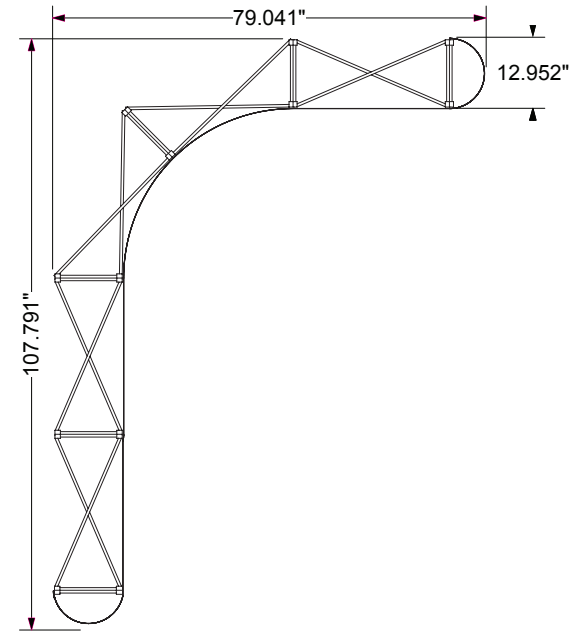

## Frame Assembly

1



2

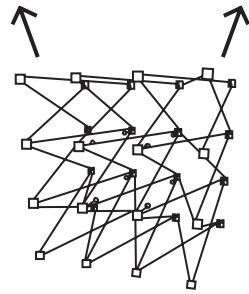

3

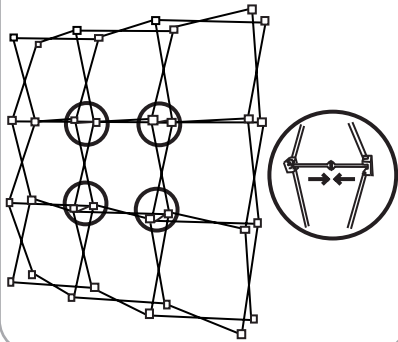

4

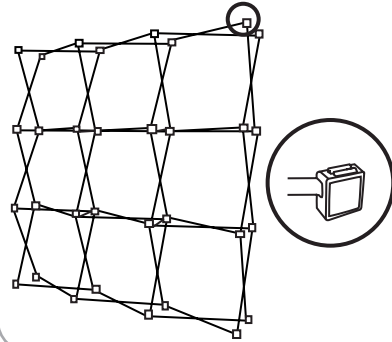

5

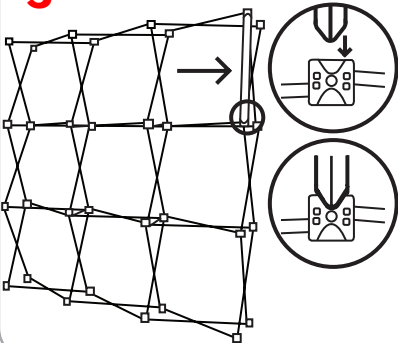

6

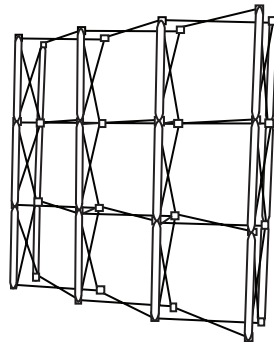

## Star Shape Coyote

1 Assemble frames  
See pg. 3 Steps 1-6

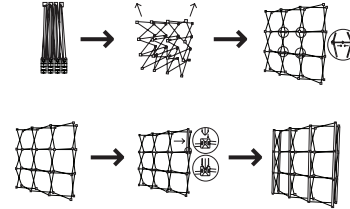

2

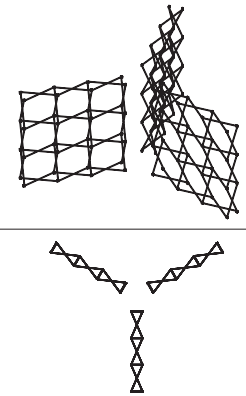

3 Apply Endcaps

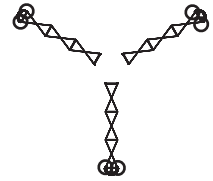
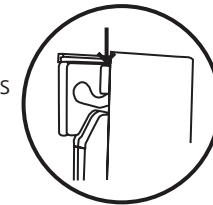

4 Apply Graphics

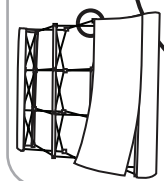
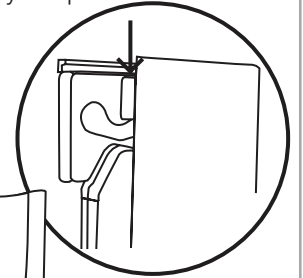

5

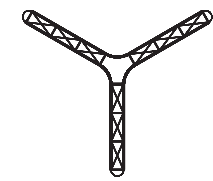
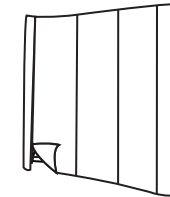

6

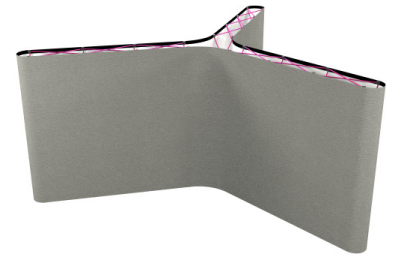

## L Shape Coyote

- 1** Assemble frames  
See pg. 3 Steps 1-6

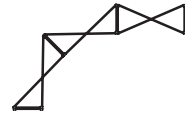
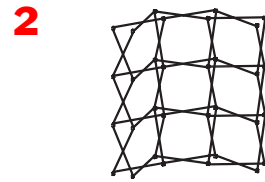
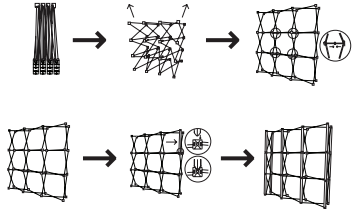

- 3** Apply Endcaps

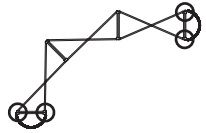
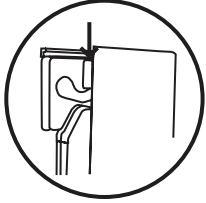

- 4** Apply Graphics

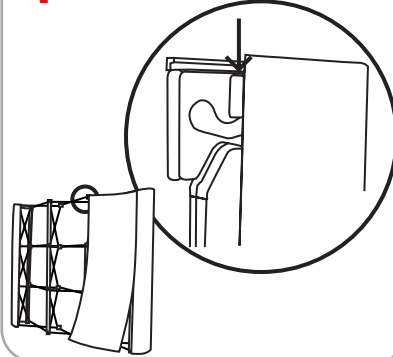

- 5**

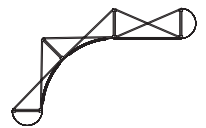
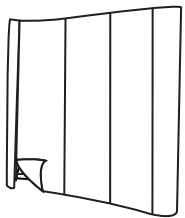

- 6**

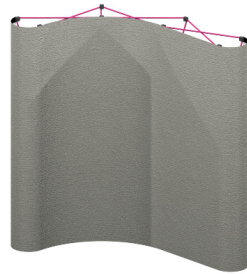

## Lights

- 1**

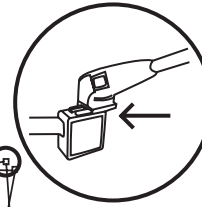
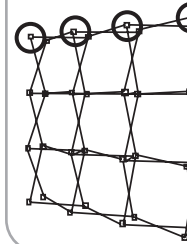

- 2**

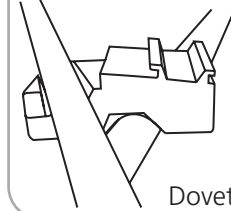

Dovetail Attachment

### L-Shape Graphic Dimensions

Panel	inches	Graphic Size	millimeters
Front Curved Panel	25.06" w x 87.75" h	636.52mm w x 2224.09mm h	
Straight Panel	28.875" w x 87.5625" h	733.04mm w x 2224.09mm h	
Endcap Curved	23.5" w x 87.5625" h	596.9mm w x 2224.09mm h	
Endcap Flat	12.5" w x 87.5625" h	381mm w x 2224.09mm h	
Back Curved Panel	35" w x 87.5625" h	889mm w x 2224.09mm h	

### Star Graphic Dimensions

Panel	inches	Graphic Size	millimeters
Curved Panel	23.5" w x 87.5625" h	596.9mm w x 2224.09mm h	
Straight Panel	28.875" w x 87.5625" h	730.25mm w x 2224.09mm h	
Endcap Curved	23.5" w x 87.5625" h	596.9mm w x 2224.09mm h	
Endcap Flat	12.5" w x 87.5625" h	381mm w x 2224.09mm h	