

FORMULATE HC5

Horizontal Curve

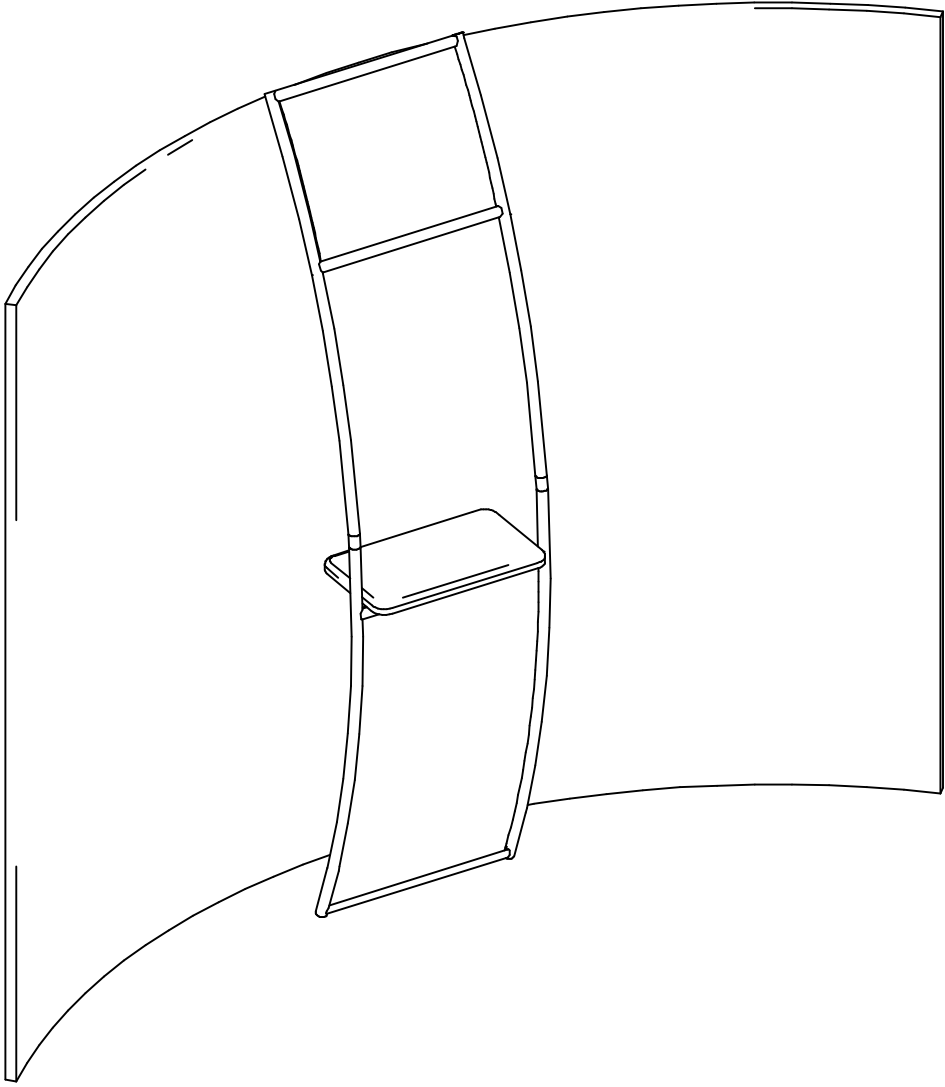

***WARNING: Redesign of this exhibit without approval by ORIGIN may result in dangerous and unsafe structures. ORIGIN disclaims any responsibility for redesigned exhibits it does not approve in writing.**

ORDER#
DATE:

FORMULATE HC

Horizontal Curve

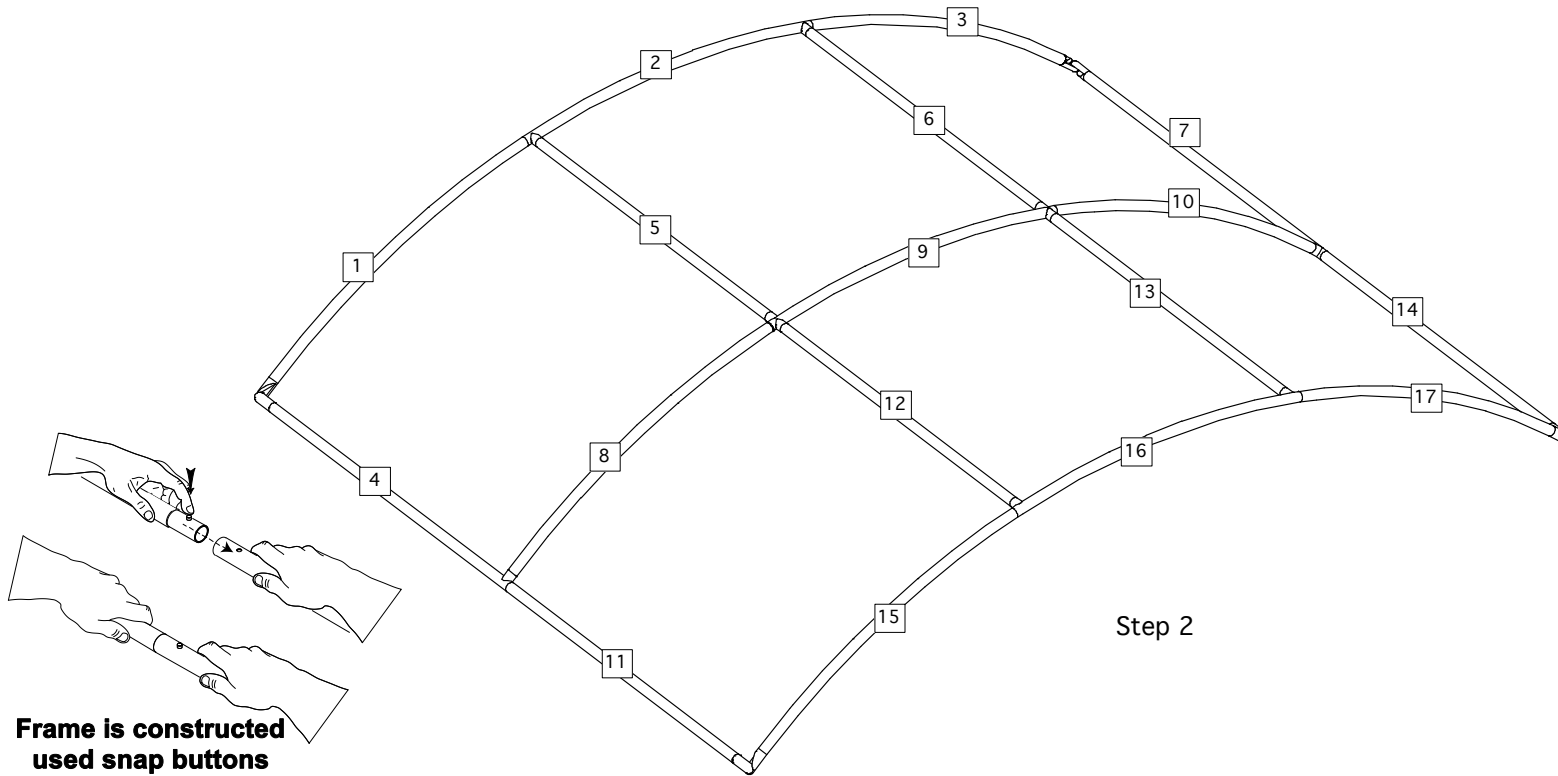

Frame is constructed used snap buttons

Step 2

Fabric structure assembly

Step 1. Unpack small items from case then pull out large tube bag. Ground cloth should be used to keep frame & fabric clean.

Step 2. Assemble frame in numerical order as shown on right. Numbers will be on the back side of the tube. It is best to assemble with the frame laying flat as shown and set upright after the fabric is attached.

Step 3. Stretch fabric over frame.

- When working with fabric use gloves or clean hands and keep fabric away from dirty surfaces.

Pull fabric over frame and secure with zipper.

Step 4. Stand unit upright.

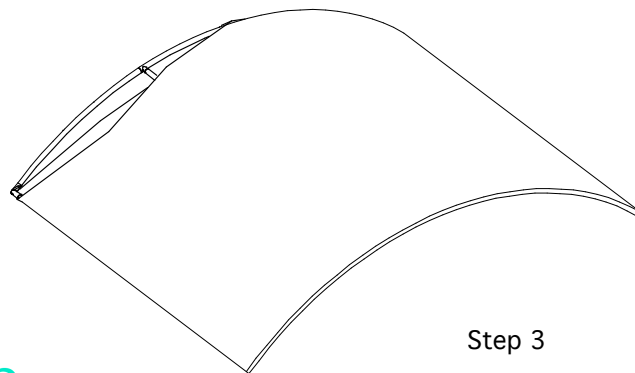

Step 3

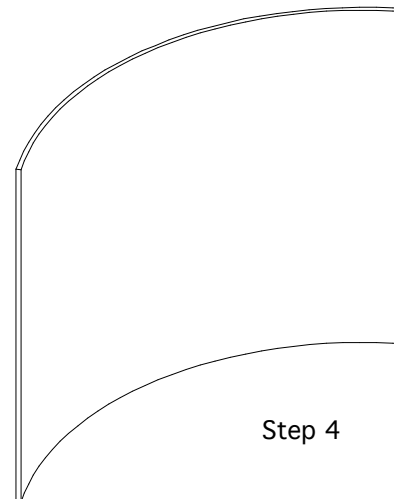

Step 4



***WARNING: Redesign of this exhibit without approval by ORIGIN may result in dangerous and unsafe structures. ORIGIN disclaims any responsibility for redesigned exhibits it does not approve in writing.**

ORDER#
DATE:

Graphic Header

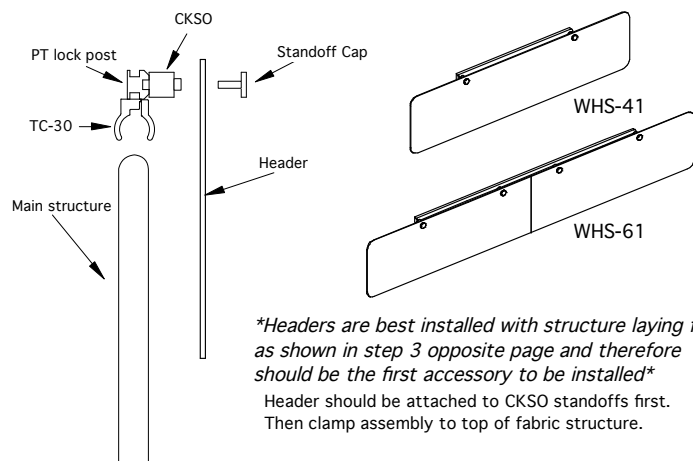

Headers are best installed with structure laying flat as shown in step 3 opposite page and therefore should be the first accessory to be installed
Header should be attached to CKSO standoffs first. Then clamp assembly to top of fabric structure.

Lighting

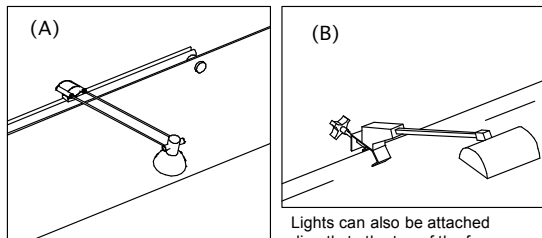

Lights may be attached to top of units with headers by using a standard Nimlink clip into the PT header rail. (A)

Lights can also be attached directly to the top of the frame using a T30 clip. (B)

Packing

All tubes except side mount counter supports should be put into the tube bag.
Pack tube bag first and unpack last.

Accessories should be packed in middle of case.

Fabric should be folded and put into smaller zippered bag.
Pack fabric bag last and unpack first.

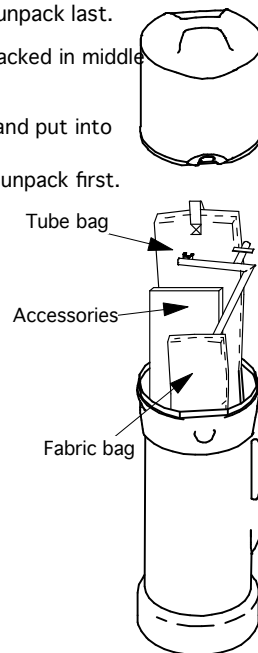

Shelf Support

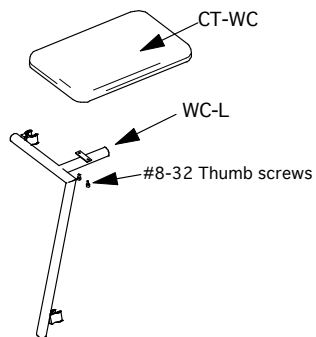

Side counter supports should be attached to side of main frame so that top of support is 39" from ground. Then attach counter top to support with thumb screws.
WC-R, not shown, attaches to right side of frame.

Literature Holder

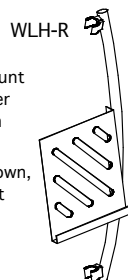

Clamp side mount literature holder to side of main structure.

WLH-L, not shown, attaches to left side of frame.

FORMULATE Accessories

Accessory Set up

Accessories should be installed after fabric structure is assembled and fabric is put on frame. If using header, install header first.



***WARNING: Redesign of this exhibit without approval by ORIGIN may result in dangerous and unsafe structures. ORIGIN disclaims any responsibility for redesigned exhibits it does not approve in writing.**

ORDER#
DATE: